

HOW TO INSTALL IN A VEHICLE

instruction booklet
model CS12200

ravaTM au



rava[®]

IMG-0087E

**IMPORTANT: KEEP THIS INSTRUCTION BOOKLET IN THE PLACE
PROVIDED AT THE BACK OF THE CHILD RESTRAINT**

IMPORTANT:

Before installation and use of this child restraint check that it is suitable for the size of your child.

Refer to the shoulder height label information on pages 15 and 25 of the USE Instructions.

Which way to face the restraint?

Install facing the back of the vehicle for babies and small toddlers. See USE Instructions page 15.

Install facing the front of the vehicle for bigger toddlers and small children. See USE Instructions page 25.

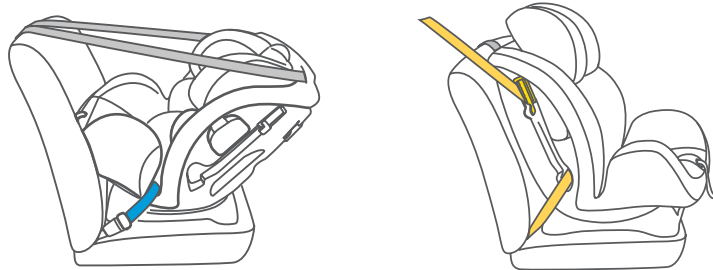

FRONT OF VEHICLE →

DO NOT USE THIS CHILD RESTRAINT UNTIL YOU HAVE READ AND UNDERSTOOD THE INSTRUCTIONS IN THIS USER GUIDE AND IN YOUR VEHICLE OWNERS MANUAL

BLUE = rearward facing information

YELLOW = forward facing information

Distributed by:
Baby Bunting Pty. Ltd.

For after sales service, please contact:
APB Pty Ltd , 82 Bellingara Road, Miranda
NSW 2228 Ph: 02 8543 5570

CONTENTS

- Quick Reference & Pictorial Guide - Rear facing Vehicle Belts 2 - 4
- Quick Reference & Pictorial Guide - Rear facing ISOFIX 5-7
- Quick Reference & Pictorial Guide - Forward facing Vehicle Belts 8 - 11
- Quick Reference & Pictorial Guide - Forward facing ISOFIX 12 - 14
- WARNINGS** 15
- ADDITIONAL WARNINGS 16&17
- Features 18&19

REAR FACING INSTALLATION

- Recline Angle 20
- Installing the Restraint using Vehicle Belts 21
- Vehicle Belts CHECKLIST 22 & 23
- Installing the Restraint using ISOFIX compatible connectors 24 & 25
- ISOFIX CHECKLIST 26 & 27

FORWARD FACING INSTALLATION

- Recline Angle 28
- Installing the Restraint using Vehicle Belts 29 & 30
- Vehicle Belt CHECKLIST 31& 32
- Installing the Restraint using ISOFIX compatible connectors 33
- ISOFIX CHECKLIST 34 & 35

TOP TETHER WARNINGS

- 36
- Features 37
- Tether Strap Use 38&39
- Tether Anchorage Installation 40 - 42

Quick Reference - Rear Facing Vehicle Belts

IMPORTANT: After reading this Quick Reference read the following instructions carefully

VEHICLE BELT INSTALLATION

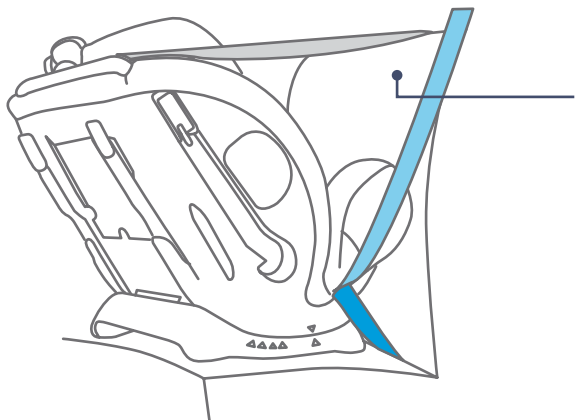

Tether Strap - must always be used when the restraint is installed in a vehicle. Ensure there are no twists in the webbing. See page 33 for tension requirement.

Side Flaps - these can be opened to provide extra side impact protection. Open door side only.

Base Recline adjustment
- restraint must be reclined correctly
See page 15

Vehicle Belts
- must always be secure and pulled tight.
See page 17

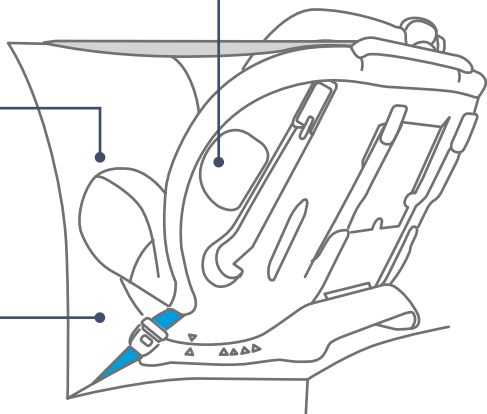

Read the whole of these instructions carefully and if there is any doubt about the method of installation, consult the child restraint manufacturer or agent, or a child restraint fitting station authorized by the relevant transport authority, or in New Zealand an agent for the vehicle.

Pictorial Guide - Rear Facing Vehicle Belts

1. Fully recline the restraint.
See page 20.

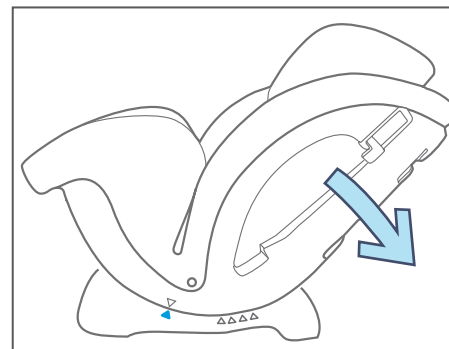

2. The white arrow on the shell must be above the blue arrow on the base.
See page 20.

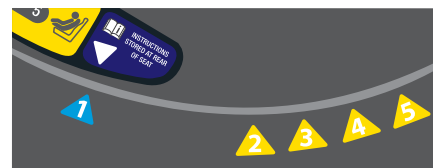

3. Place the restraint on the vehicle seat rear facing.
Pull the vehicle lap/sash belt out and pass through the slot in the restraint.
See page 21.

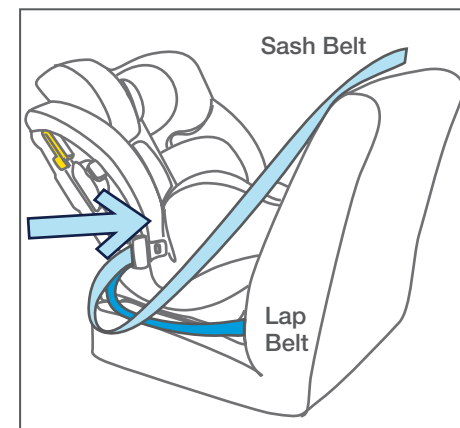

Pictorial Guide - Rear Facing Vehicle Belts

4. Pass the vehicle belts over the restraint seating surface and out the other side.
Engage the vehicle belt buckle.
See page 21.

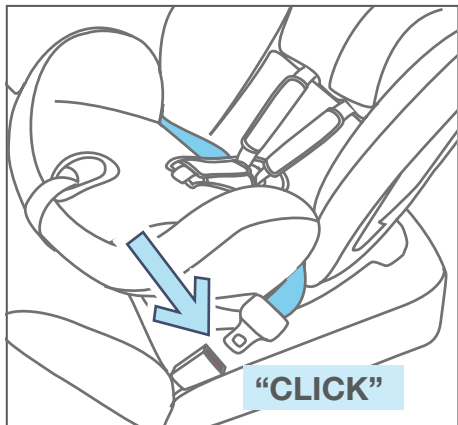

5. Ensure there are no twists in the belts.
See page 22.

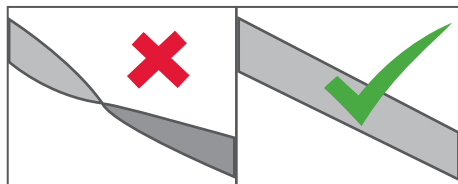

6. Pull the vehicle belts tight.
See page 22.

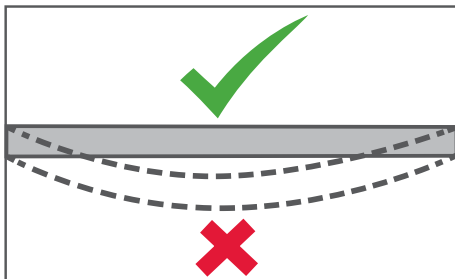

7. Connect the top tether strap.
See page 23.

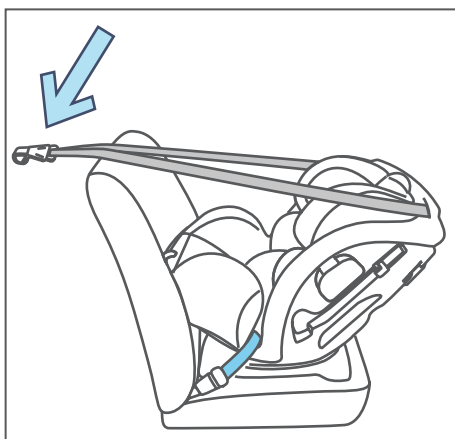

Quick Reference - Rear Facing ISOFIX

IMPORTANT: After reading this Quick Reference read the following instructions carefully

ISOFIX COMPATIBLE STRAP INSTALLATION

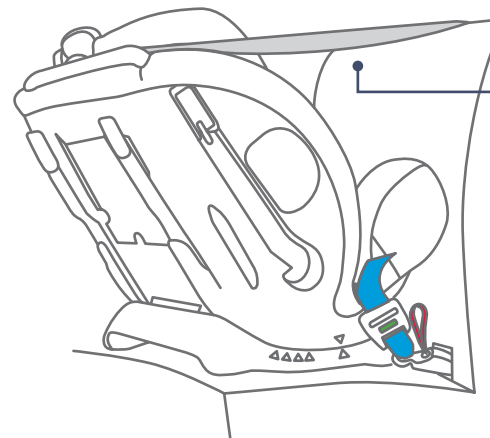

Tether Strap - must always be used when the restraint is installed in a vehicle.
Ensure there are no twists in the webbing.
See pages 33 for tension requirement.

Base Recline adjustment
- restraint must be reclined correctly
See page 15

ISOFIX compatible connector
- connector must always be securely attached to vehicle anchorage and the strap pulled tight.
See pages 20 - 22

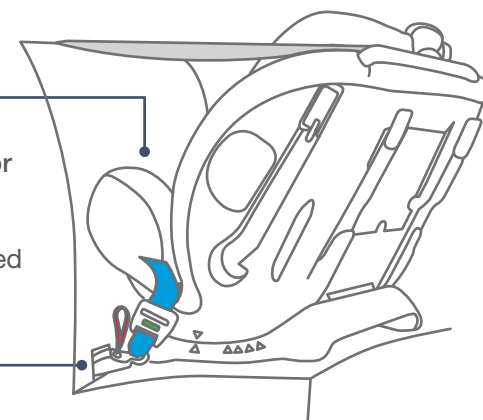

Pictorial Guide - Rear Facing ISOFIX

1. Fully recline the restraint.
See page 20.

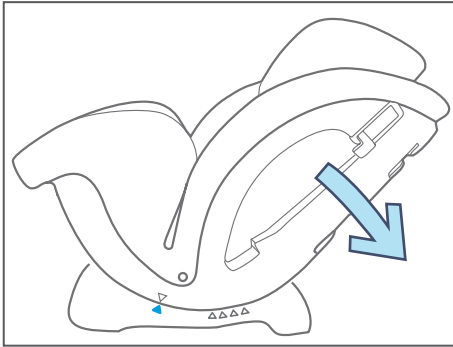

2. The white arrow on the shell must be above the blue arrow on the base.
See page 20.

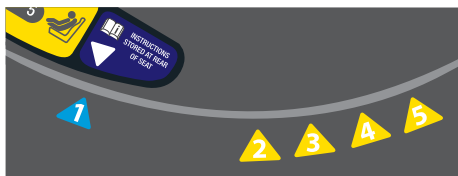

3. Place the restraint on the vehicle seat rear facing.
See page 25.

Take the ISOFIX compatible connectors out of the storage pockets on either side of the restraint. Connect each to the steel rod in the vehicle seat bight.
See page 25.

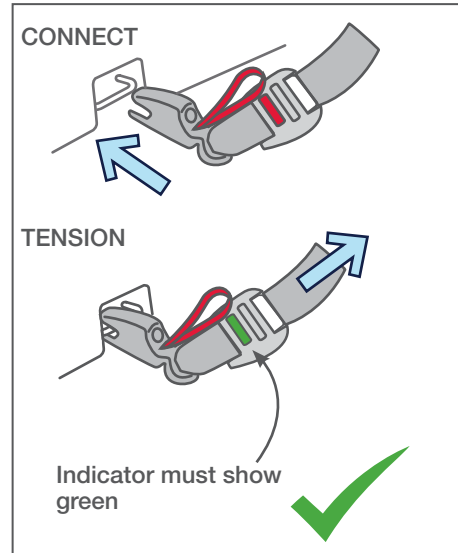

Pictorial Guide - Rear Facing ISOFIX

4. No twists in belts.
See page 27.

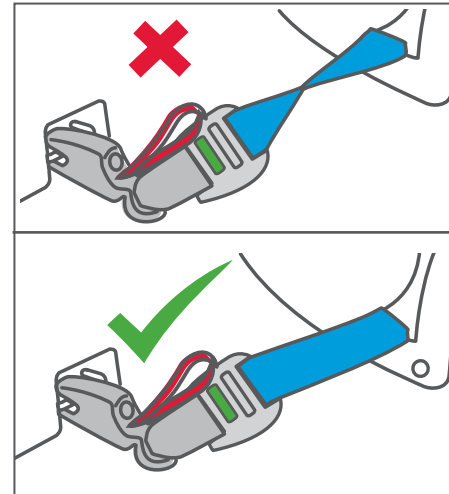

5. Belts pulled tight.
See page 26.

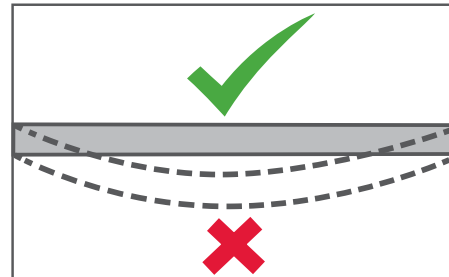

6. Check both sides are connected and the indicators are green.
See page 27.

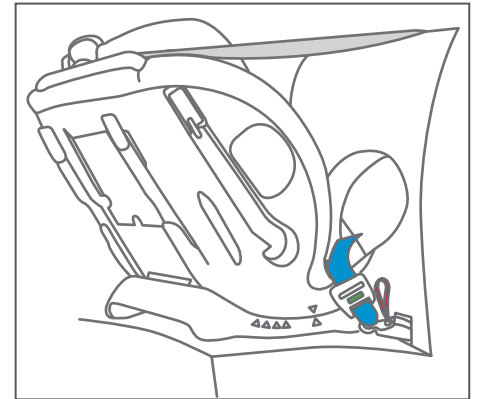

7. Connect the top tether strap.
See page 39.

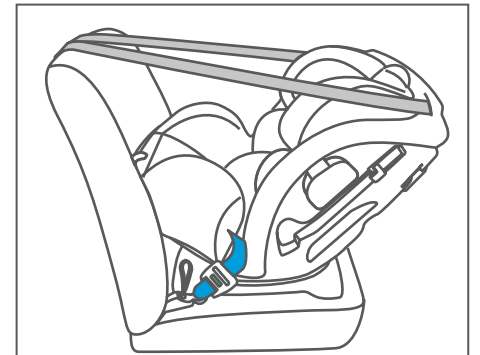

Quick Reference - Forward Facing Vehicle Belts

IMPORTANT: After reading this Quick Reference read the following instructions carefully

VEHICLE BELT INSTALLATION

Tether Strap - must always be used when the restraint is installed in a vehicle. See pages 28 & 29

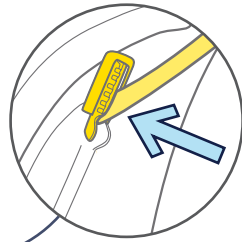

Sash Belt Lock-off - use this to hold the restraint more securely. See page 22

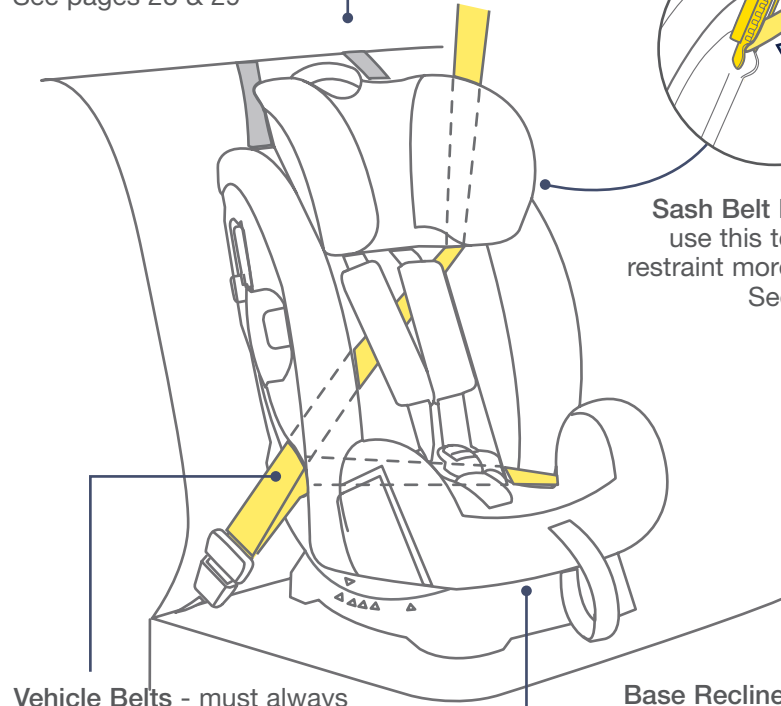

Vehicle Belts - must always be secure and pulled tight. See pages 21 - 23

Base Recline adjustment - restraint must be reclined correctly. See page 19

Pictorial Guide - Forward Facing Vehicle Belts

1. Adjust the recline angle. Select a position that gives the most comfort for your child. See page 28.

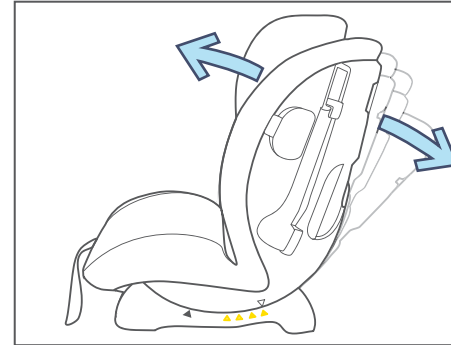

2. The white arrow on the shell must be above one of the yellow arrows on the base. See page 28.

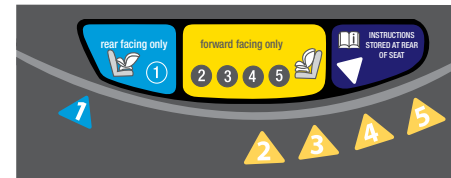

3. Place the restraint on the vehicle seat facing forward. Pull the vehicle lap/sash belt out and thread it through the vehicle belt slots at the back of the restraint. See page 29.

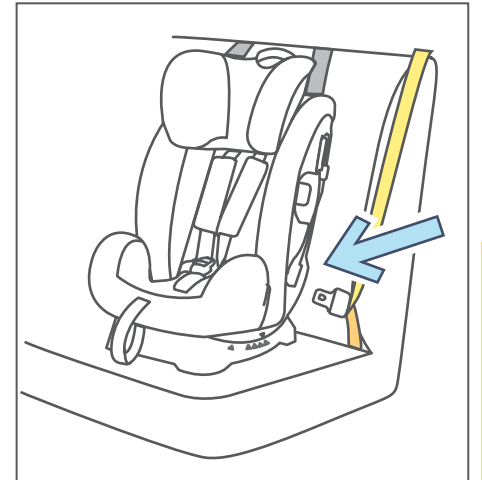

Pictorial Guide - Forward Facing Vehicle Belts

4. Engage the vehicle belt buckle.
See page 29.

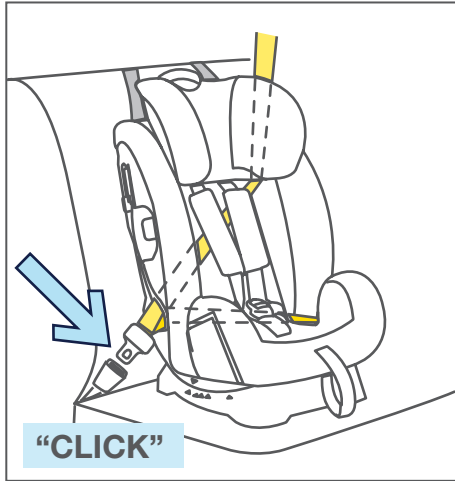

5. Ensure there are no twists in the belts.
See page 32.

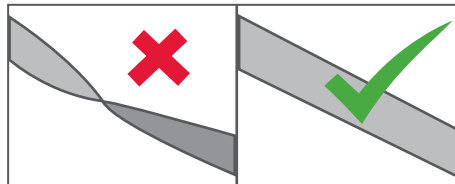

6. Press the restraint down and pull the vehicle belts tight.
See page 30.



Pictorial Guide - Forward Facing Vehicle Belts

7. Pull firmly on the vehicle sash belt. Open the lock-off and slide the sash belt into it.
See page 31.

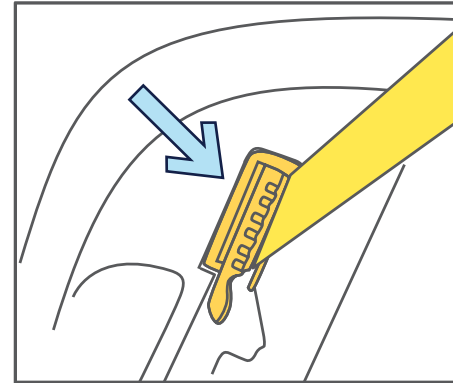

8. Check the vehicle belts are still tight.
See page 32.

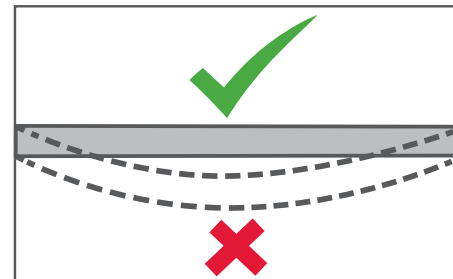

9. Connect the top tether strap.
See page 39.

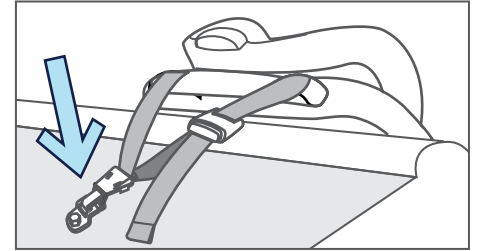

10. Store end of web in bag on back of cover.

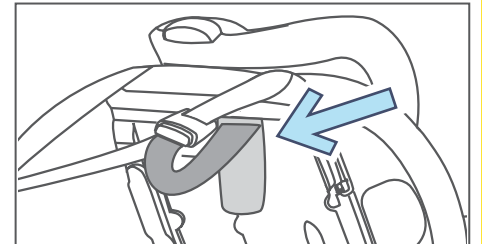

Quick Reference - Forward Facing ISOFIX

IMPORTANT: After reading this Quick Reference read the following instructions carefully

ISOFIX COMPATIBLE STRAP INSTALLATION

Tether Strap - must always be used when the restraint is installed in a vehicle. See pages 28 & 29



ISOFIX compatible connector - connectors must always be securely attached to vehicle anchorage and the straps pulled tight.

See pages 24 & 25

Base Recline adjustment - restraint must be reclined correctly. See page 19

Pictorial Guide - Forward Facing ISOFIX

1. Adjust the recline angle. Select a position that gives the most comfort for your child. See page 28.

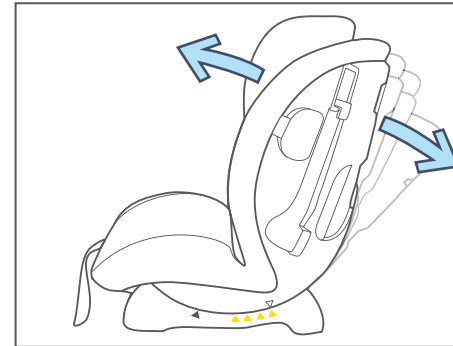

2. The white arrow on the shell must be above one of the yellow arrows on the base. See page 28.



3. Place the restraint on the vehicle seat facing forward.

Take the ISOFIX compatible connectors out of the storage pockets on either side of the restraint. Connect each to the steel rod in the vehicle seat bight.

See page 33.

CONNECT

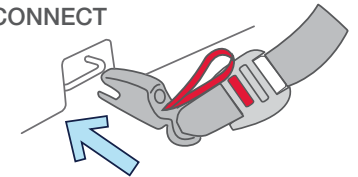

TENSION

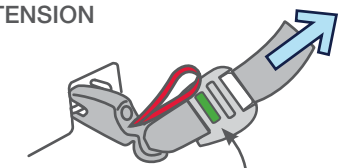

Indicator must show green



Pictorial Guide - Forward Facing ISOFIX

4. Ensure there are no twists in the straps.
See page 34.

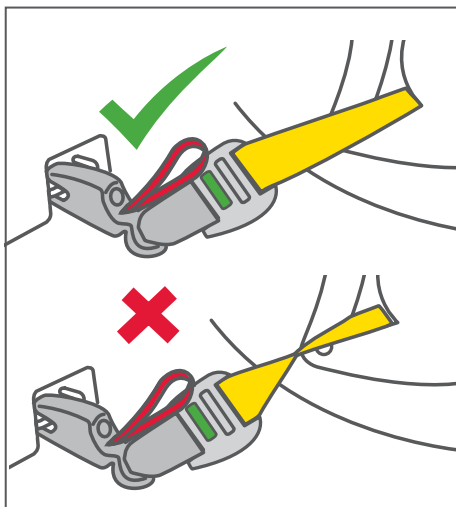

6. Connect the top tether strap.
See page 39.

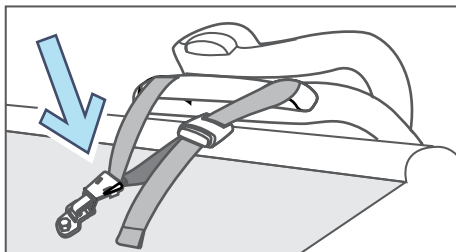

5. Press the restraint down and pull the straps tight.
See page 33.



7. Store end of web in bag on back of cover.

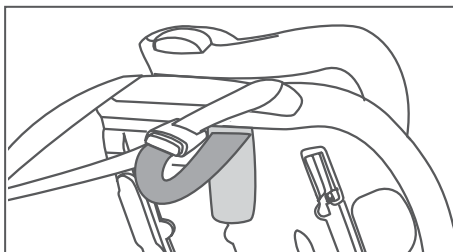

⚠ WARNINGS

GENERAL WARNINGS

- Use the restraint exactly as shown in the instructions.
- Do not alter or modify this restraint.
- Repairs must only be done by the manufacturer or agent.
- Do not allow the restraint to come into contact with polishes, oils, bleach and other chemicals.
- Destroy the restraint if it has been in a severe crash, even if no damage is visible.
- A loose harness or restraint is dangerous.
- Fit the restraint firmly to the car seat.
- **DO NOT USE A REAR FACING CHILD RESTRAINT WHERE AN AIRBAG IS FITTED IN FRONT OF THE SEATING POSITION.**
- **DO NOT LEAVE CHILDREN UNATTENDED IN THE CAR**

IMPORTANT: Do not attach the lower attachment connectors of two separate child restraints to the same ISOFIX low anchorage in your car.

Always attach the top tether strap to the child restraint upper anchorage in your car.

Child restraint lower attachment connectors and the ISOFIX low anchorages in your car are designed to withstand only those loads imposed by a correctly fitted child restraint.

NOTE: The warnings on this page are required by the Australian and New Zealand Standard AS/NZS 1754 for this type of child restraint. Other warnings specific to this child restraint will be found on the following pages and throughout these instructions.

⚠️ ADDITIONAL WARNINGS

TO BE USED WITH A LAP-SASH/LAP ONLY SEAT BELT OR ISOFIX LOW ANCHORAGES IN THE BACK OF MOST CARS WITH FORWARD FACING SEATS.

When installed rearward facing this restraint is 710 mm long, 500 mm wide and 515 mm high. Check the measurement between the front of the seat back of the rear seat and all front seats in the car in which the restraint is intended to be used to ensure the space available is sufficient.

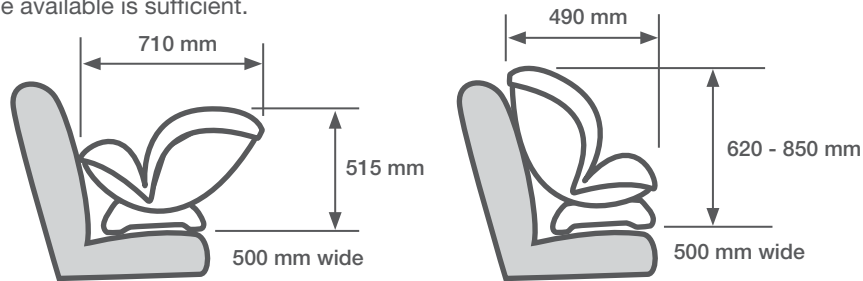

Do not use seat belt extenders if the car seat belt is not long enough to secure the child restraint. If the vehicle seat belt is not long enough to secure the restraint seek advice from a child restraint fitter.

Read carefully the whole of the instructions for the installation, and in the event of doubt about the method of installation, consult the child restraint manufacturer or agent, or a child restraint fitting station authorized by the relevant transport authority, or in New Zealand, consult the agent for the vehicle.

Aftermarket accessories (i.e. items not provided in the box with the child restraint), may not have been tested for use with this child restraint and if used, may lower the level of protection offered possibly leading to injury or death.

Any aftermarket accessory used should be compliant with AS/NZS 8005 (Accessories for child restraints for use in motor vehicles) and stated as suitable for use with this child restraint.

⚠️ ADDITIONAL WARNINGS

Only install child restraint in a forward facing vehicle seat. Never install in a seat that faces the rear or the side of the vehicle.

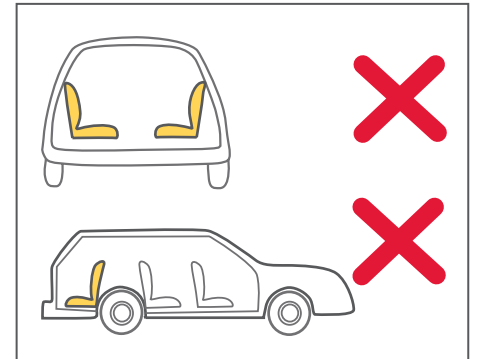

Never install the Child Restraint in a seat with a front airbag. DEATH or SERIOUS INJURY may occur. Refer to your vehicle Owners Manual for airbag warnings and information.



Features

- | | | | |
|---|---------------------------------|----|------------------------------|
| 1 | Adjustable Headrest | 7 | Crotch Pad |
| 2 | Seat Pad | 8 | Shoulder Harness Strap |
| 3 | Harness QR Buckle | 9 | Shoulder Harness Strap Cover |
| 4 | Harness Adjuster (under cover) | 10 | Infant Body Support |
| 5 | Harness Adjuster Webbing | 11 | ISOFIX strap storage pocket |
| 6 | Recline Angle Adjustment Handle | | |

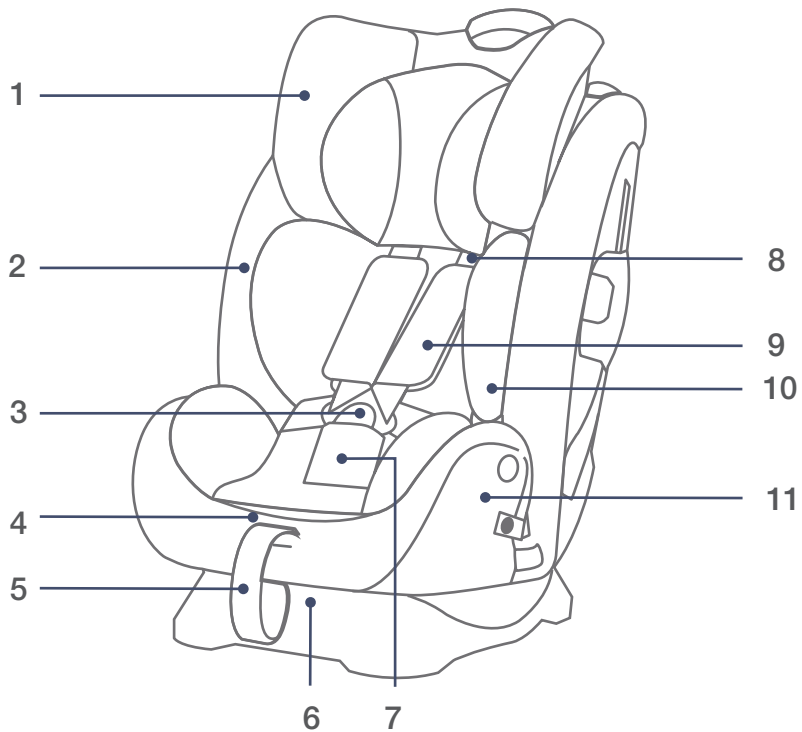

Features

- | | | | |
|----|------------------------------|----|----------------------------------|
| 12 | Top Tether Anchorage | 18 | Base |
| 13 | Top Tether | 19 | Top Tether End Storage Bag |
| 14 | Head Support Adjuster Handle | 20 | Seat Shell |
| 15 | Sash Belt Lock-off Device | 21 | Forward-Facing Vehicle Belt Slot |
| 16 | Extra side impact protection | 22 | Rear-Facing Vehicle Belt Slot |
| 17 | Instructions Storage | 23 | ISOFIX strap storage pocket |

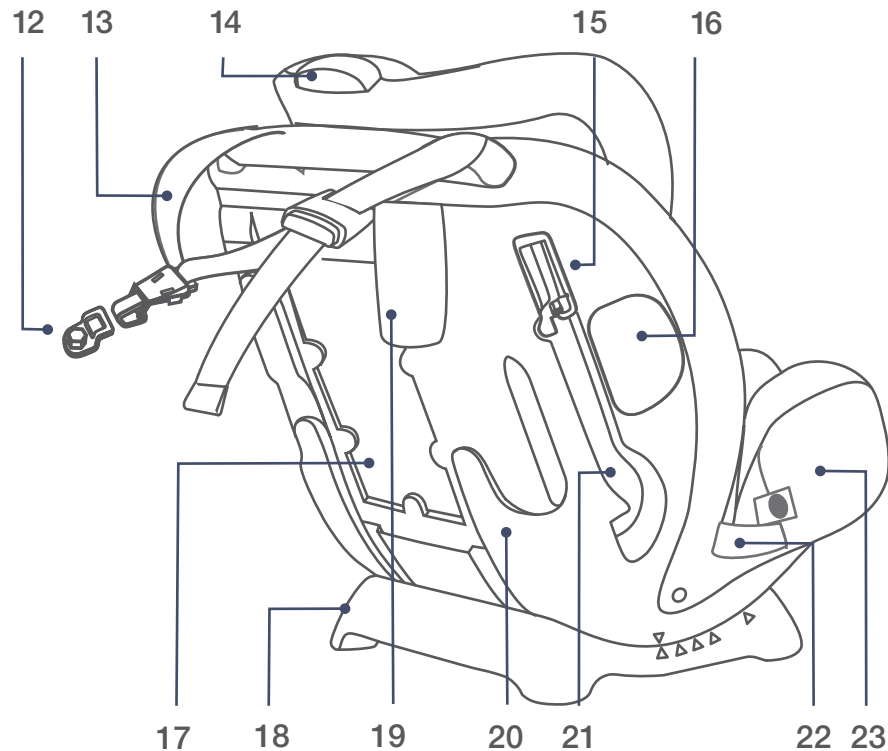

Recline Angle

This restraint should be installed in the rear seat. See Page 17.

Correct Recline Angle

When used rear facing the restraint must always be fully reclined. The white arrow on the shell must be above the blue arrow on the base.

IMPORTANT: A correct recline angle is essential for your baby's safety.

To Adjust:

1. Pull the release handle on the shell fully forward.

2. Rotate the shell until the white arrow is above the blue arrow.

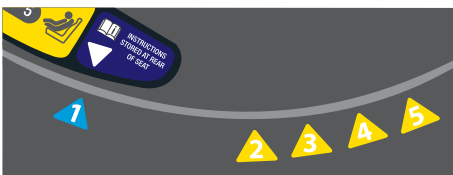
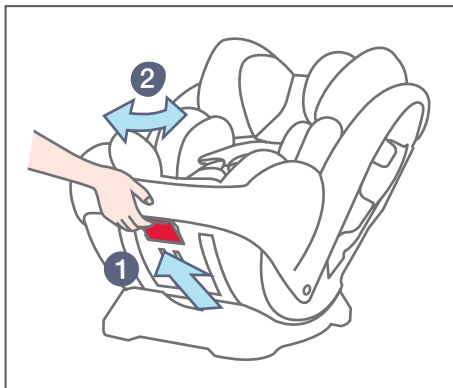
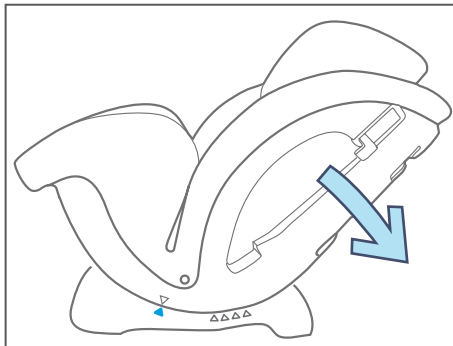

Using Vehicle Belts

Place the restraint on the vehicle seat rear facing.

See page 17 for recommended positions in the vehicle.

Pull the vehicle lap/sash belt out and pass through the slot in the restraint.

Pass the vehicle belts over the restraint seating surface and out the other side.

Ensure there are no twists in the belts.

Engage the vehicle belt buckle.

Pull the vehicle belts tight.

Connect the top tether strap. See pages 38 & 39 for more information

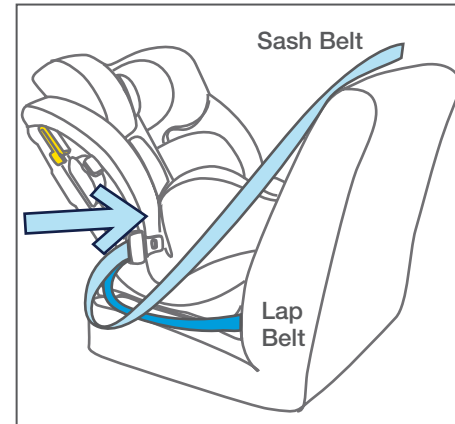

REARWARD FACING BELT PATH

Look for this label showing the correct path for the vehicle belts

REARWARD FACING BELT PATH

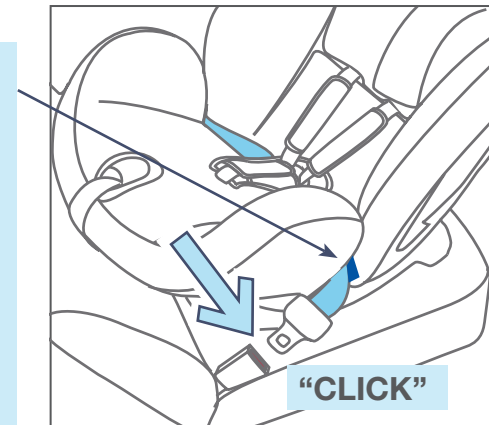

Vehicle Belt Checklist

The installed restraint should look like this:

1 restraint fully reclined, vehicle belts securely connected to the belt buckle.

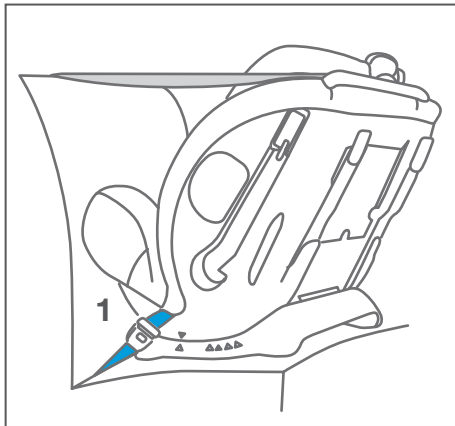

2 Belts pulled tight.

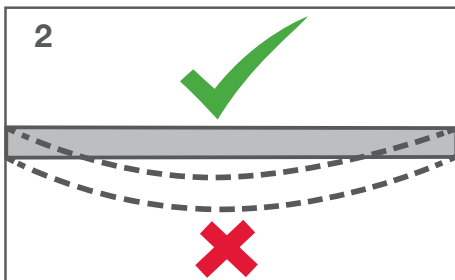

3 No twists in belts.

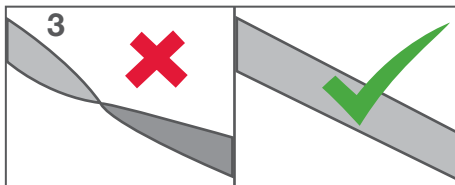

Vehicle Belt Checklist

4 Both lap and sash belt threaded through the slots in the side wings.

IMPORTANT: the vehicle belts must be fully down in the slots in the side wings

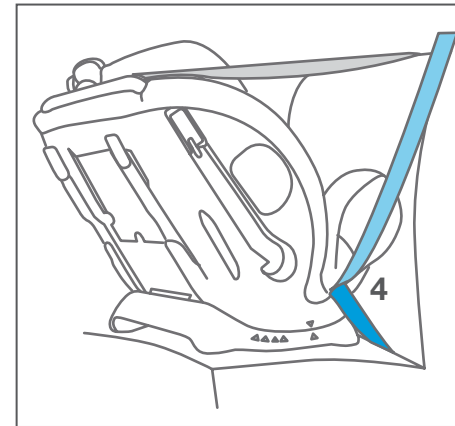
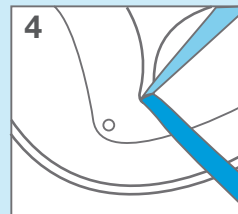

5 Tether Strap connected to the anchorage and correctly tensioned.
Store end of web in bag on back of cover.
See pages 38 & 39 for more information.

IMPORTANT
Some vehicles have airbags attached to the sash belt.
DO NOT install the restraint using this type of belt.
If in doubt refer to the vehicle owners manual or an approved child restraint fitter.

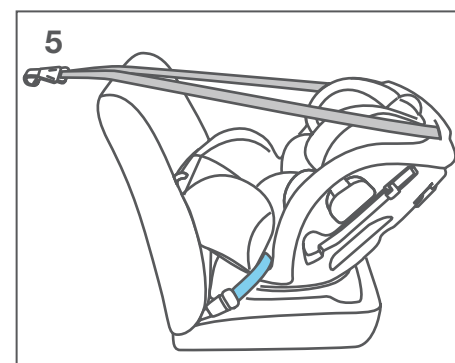

Using ISOFIX compatible connectors

Some vehicles are fitted with low anchorage points specifically designed to allow connection by suitably equipped child restraints.

These are generally known as ISOFIX low anchorage points and are found at the bottom of the vehicle back seat backrest.

If the ISOFIX low anchorage points are not clearly visible the vehicle seat will be marked with appropriate labels to show their location. The marking will be adjacent to the anchorage points.

If in doubt that the vehicle is fitted with such points check the vehicle Owners Manual.

Some vehicles sourced from the USA may be marked LATCH. ISOFIX and LATCH anchorage points are identical.

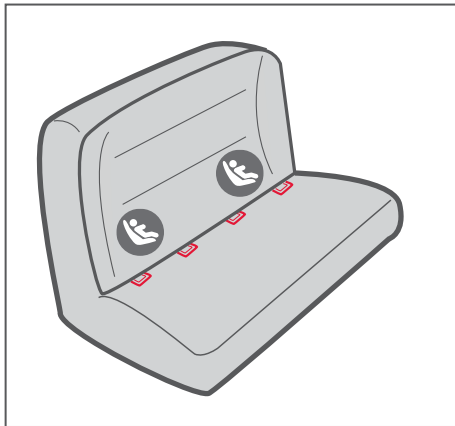

ISOFIX

LATCH

Using ISOFIX compatible connectors

Fully recline the restraint. See page 20.

Place the restraint on the vehicle seat rear facing.

See page 17 for recommended positions in the vehicle.

Take the ISOFIX compatible connectors out of the storage pockets on either side of the restraint.

Connect each to the steel rod in the vehicle seat bight.

Ensure there are no twists in the webbing.

Pull the straps tight.

NOTE: when using or storing the straps ensure they are not twisted around the lap belt portion of the harness.

Connect the top tether strap.

Store end of web in bag on back of cover.

See pages 38 & 39 for more information

CONNECT

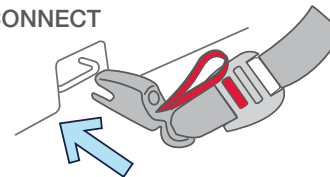

TENSION

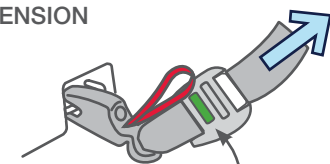

Indicator must show green

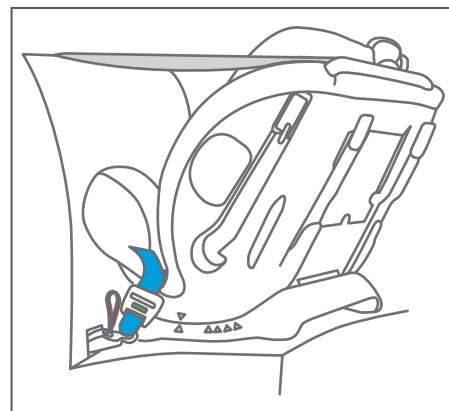

ISOFIX checklist

Checklist

The installed restraint should look like this:

1 Vehicle belts securely connected to the belt buckle,

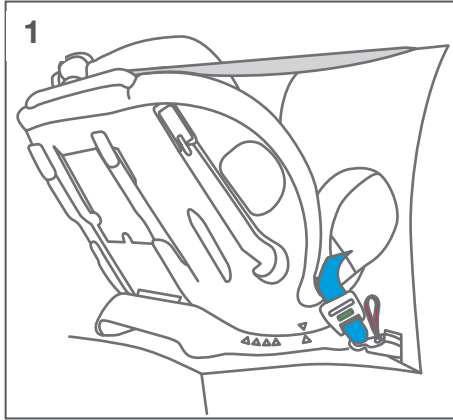

2 Belts pulled tight,

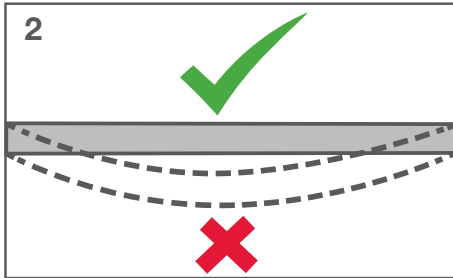

ISOFIX checklist

3 No twists in belts,

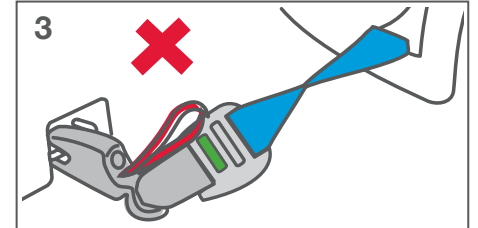

4 Belts tensioned, indicator shows green

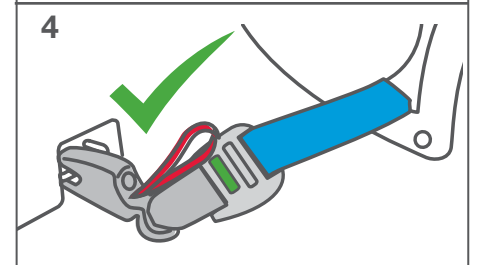

5 Tether strap connected to the anchorage and correctly tensioned.

Store end of web in bag on back of cover.

See pages 38 & 39 for more information.

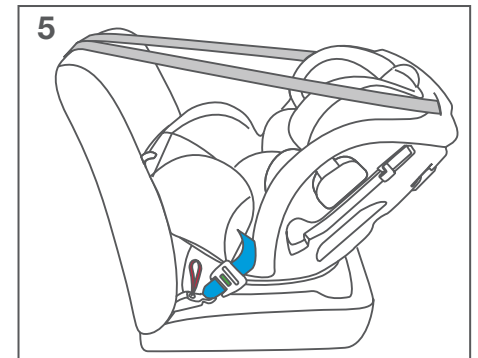

Recline Angle

Correct Recline Angle

When used forward facing the restraint must always be correctly reclined. The white arrow on the shell must be above one of the yellow arrows on the base.

Select a position that gives the most comfort for your child.

IMPORTANT A correct recline angle is essential for your child's safety.

DO NOT use the position marked by the blue arrow when the restraint is forward facing.

To Adjust:

1. Pull the release handle on the shell fully forward.
2. Rotate the shell until the white arrow is above one of the yellow arrows.

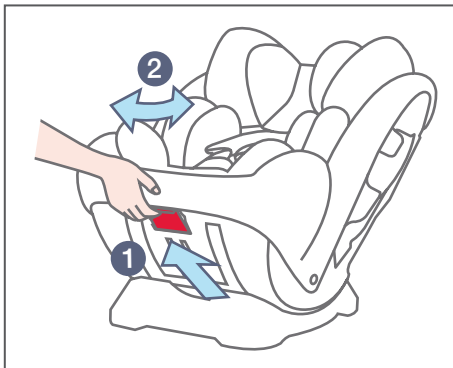
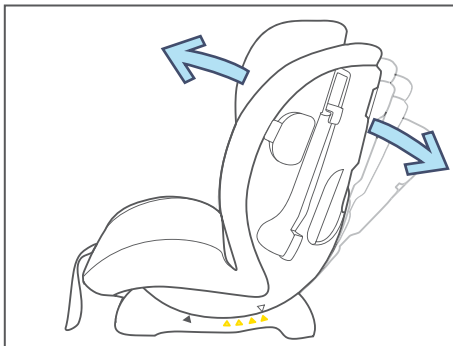

Using Vehicle Belts

See page 17 for recommended positions in the vehicle.

Place the restraint on the vehicle seat forward facing.

Pull the vehicle lap/sash belt out and thread it through the vehicle belt slots at the back of the child restraint.

Engage the vehicle belt buckle.

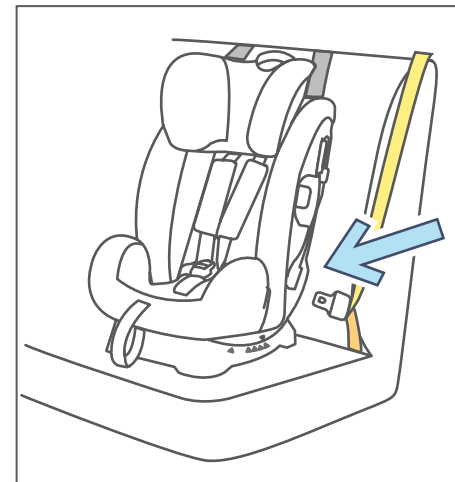

FORWARD-FACING BELT PATH

Look for this label showing the correct path for the vehicle belts

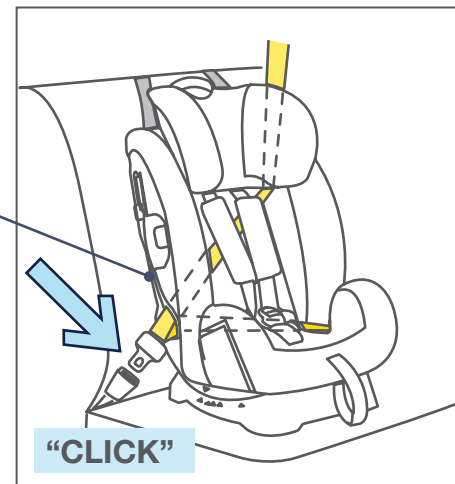

FORWARD FACING INSTALLATION

Using Vehicle Belts

While pressing the child restraint down firmly into the vehicle seat, pull the vehicle sash belt until both lap and sash belts are tight.

Maintain tension on the vehicle sash belt and open the lock-off device and slide the sash belt into it.

CAUTION: always check that when the sash belt is locked in place it is fully tensioned. There must be no slack in the belts behind the seat.

Connect the top tether strap. See pages 28 & 29 for more information

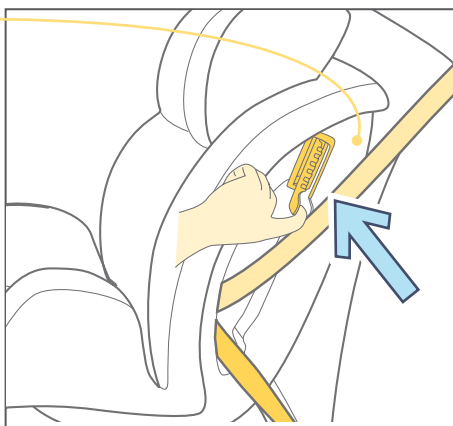
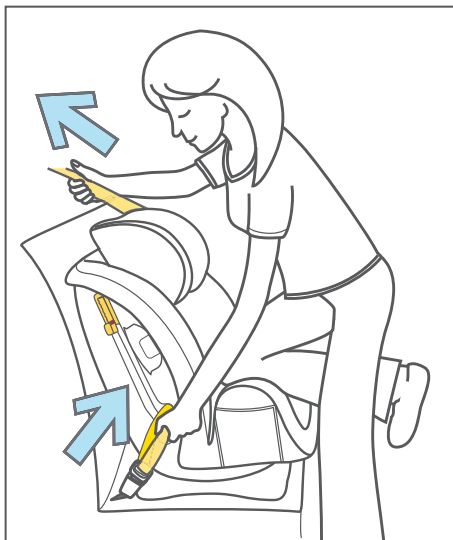

FORWARD-FACING BELT PATH

Look for this marking showing the correct path for the vehicle sash belts



Vehicle Belt checklist

Checklist

The installed restraint should look like this:

1 Vehicle belts securely connected to the belt buckle,

2 Sash Belt locked in guide.

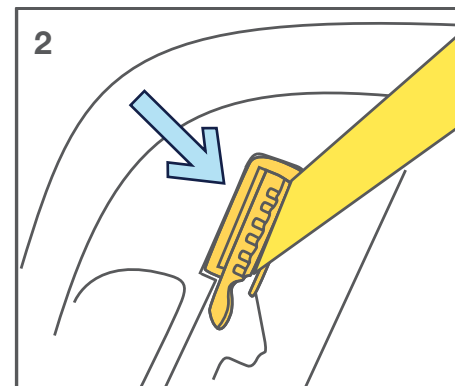
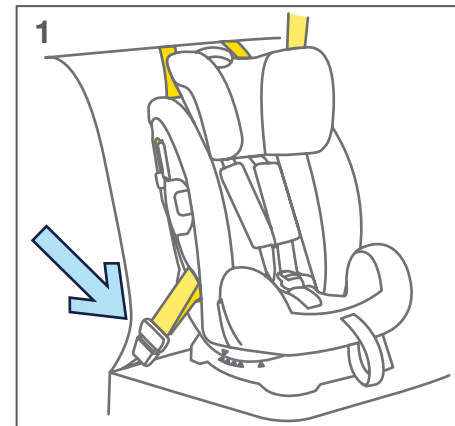

IMPORTANT

Some vehicles have airbags attached to the sash belt.
DO NOT install the restraint using this type of belt.
If in doubt refer to the vehicle owners manual or an approved child restraint fitter.

Vehicle Belt checklist

3 No twists in belts,

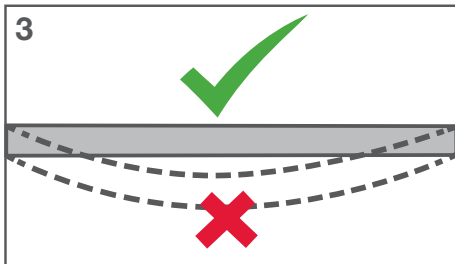

4 Belts pulled tight,

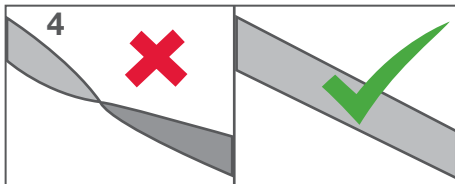

5 Tether Strap connected to the anchorage and correctly tensioned.

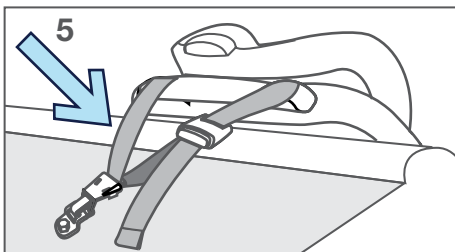

6 Store end of web in bag on back of cover.

See page 39 for more information.

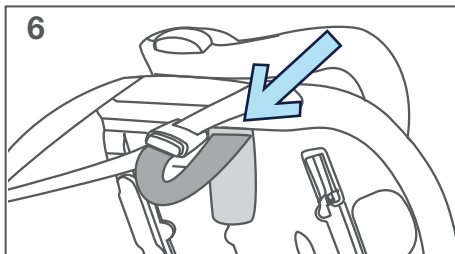

Using ISOFIX compatible connectors

See page 15 for information on the ISO-FIX anchorages in vehicles.

See page 17 for recommended positions in the vehicle.

See page 28 for recommended recline angle.

Place the restraint on the vehicle seat forward facing.

Take the ISOFIX compatible connectors out of the storage pockets on either side of the restraint.

Connect each to the steel rod in the vehicle seat bight.

Ensure there are no twists in the webbing.

Pull the straps tight.

CONNECT

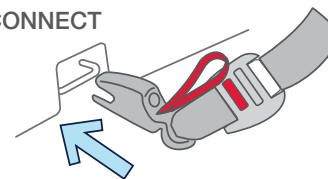

TENSION

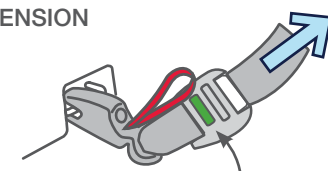

Indicator must show green

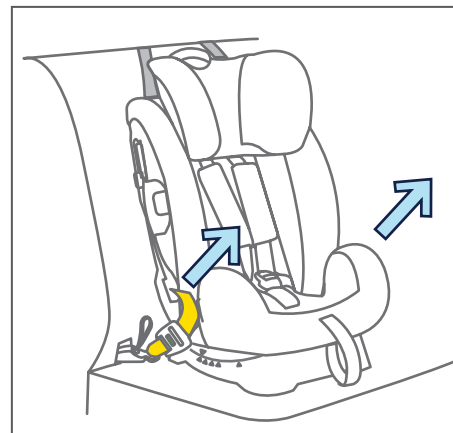

ISOFIX checklist

The installed restraint should look like this:

1 ISOFIX connectors securely connected to the anchorages.

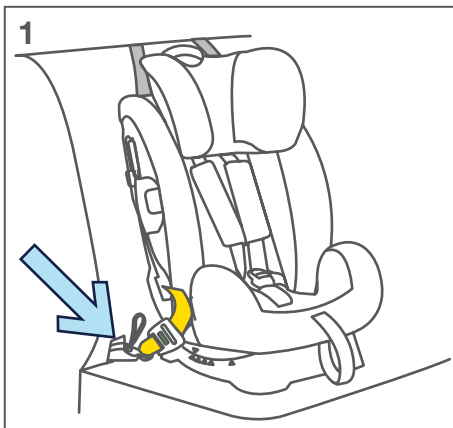

2 No twists in straps, Indicator shows green

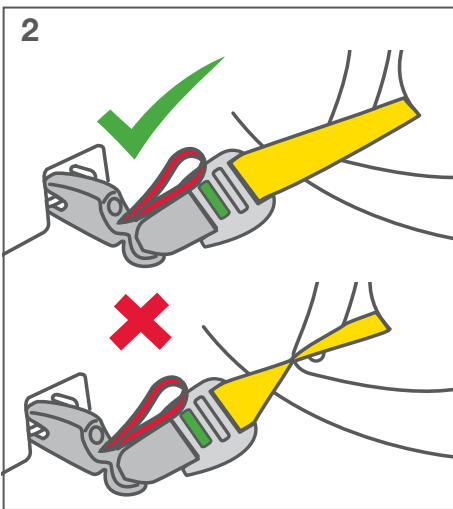

ISOFIX checklist

3 Straps pulled tight,

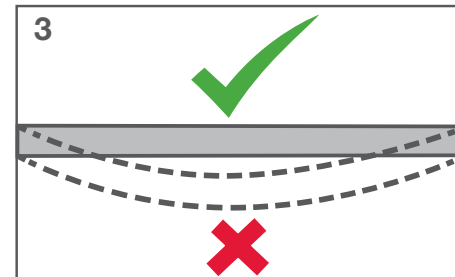

4 Tether Strap connected to the anchorage and correctly tensioned.

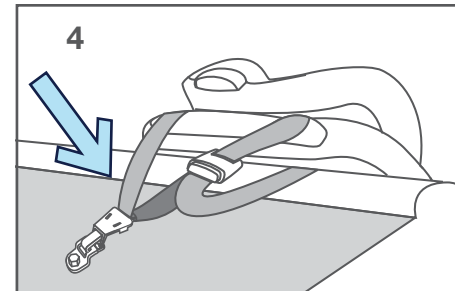

5 Store end of web in bag on back of cover.

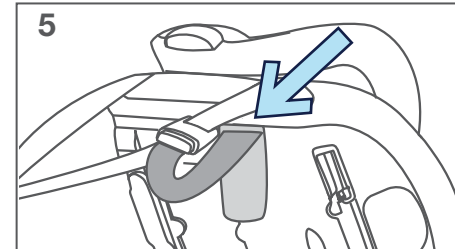

See page 39 for more information.

TOP TETHER

WARNINGS

THIS RESTRAINT MUST BE ATTACHED TO A CHILD RESTRAINT UPPER ANCHORAGE POINT IN THE CAR.

REFER TO CAR OWNERS HANDBOOK FOR LOCATION OF UPPER ANCHORAGE POINTS.

REFER TO A CHILD RESTRAINT FITTING STATION IF NO ANCHORAGE POINTS ARE IN THE MOTOR CAR.

THIS RESTRAINT IS NOT SUITABLE FOR USE WHERE THE TOP TETHER STRAP MAY FALL INTO A SPLIT IN THE SEAT BACK OR OFF THE SIDE OF THE SEAT.

Always secure the loose end of the top tether strap to prevent it hanging out of the car or being accessible by the child. Store it in the bag attached to the back of the cover.

Do not use the child restraint where this strap may fall into a split in the seat back or off the side of the seat.

ALWAYS ATTACH HOOK AND REMOVE SLACK.

CAUTION: CHILDREN CAN BE INJURED OR RESTRAINTS AND TOP TETHER STRAP DAMAGED BY UNSECURED CARGO IN A COLLISION. SECURE OR REMOVE HAZARDOUS CARGO BEFORE USING THIS CHILD RESTRAINT.

Top Tether - Features

This child restraint has a tether strap permanently attached to the back of the seat.

Always use this tether strap.

Connect the tether strap to the built-in anchorage fitting in the vehicle, or if there is not one available, install the anchor fitting supplied with this restraint by following the instructions on the next pages.

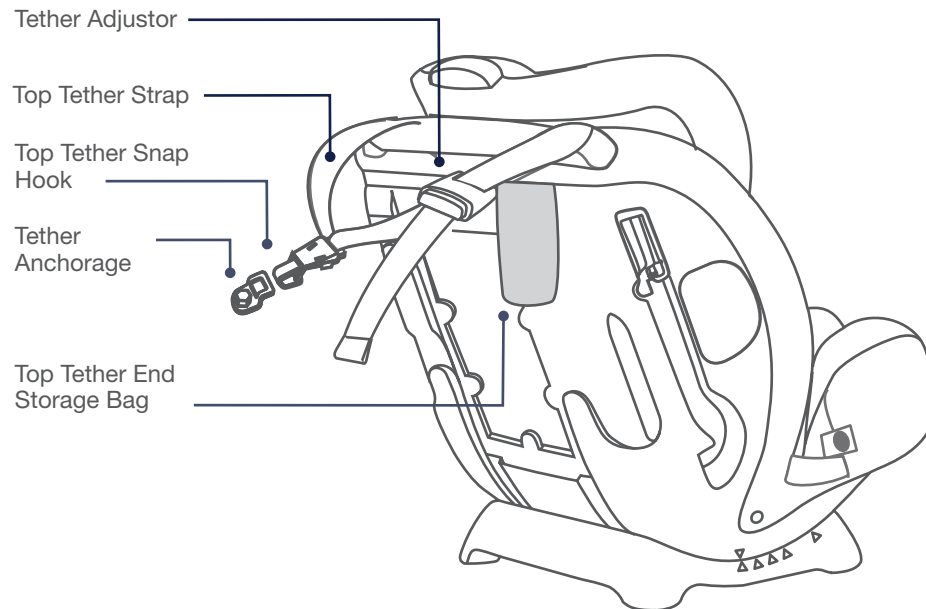

Top Tether Use

Adjust the tether tension until the webbing is pulled tight.

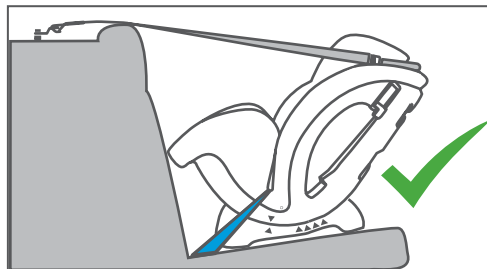

Do not adjust so tight that it lifts the child restraint off the vehicle seat.

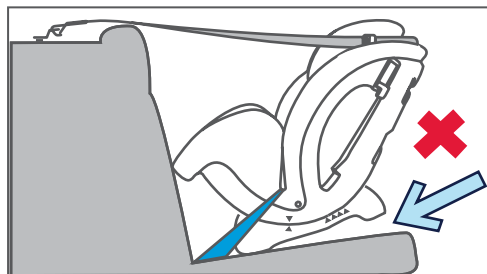

Straps must not be twisted.

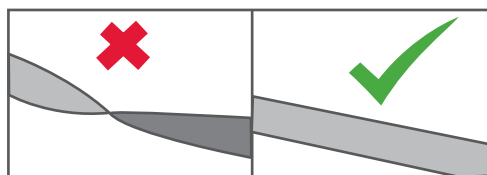

Pull straps pulled tight.

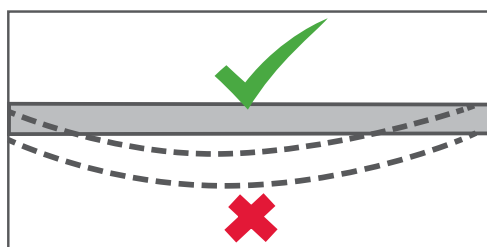

Top Tether Use

Always connect the snap hook securely to the anchorage fitting.

In some vehicles without a fixed parcel shelf an extension tether strap may be required. These are available in several different lengths and can be obtained from child restraint retail outlets.

Increase tether tension by pulling web out. If the web is stiff to pull through the adjuster also press the release button.

Reduce tension by pressing release button and pulling web out.

Store end of web in bag on back of cover.

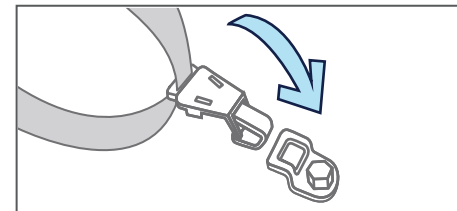

Pull web to increase tension

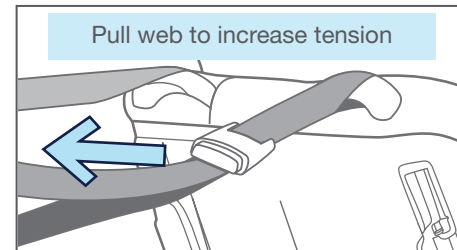

Press button to reduce tension

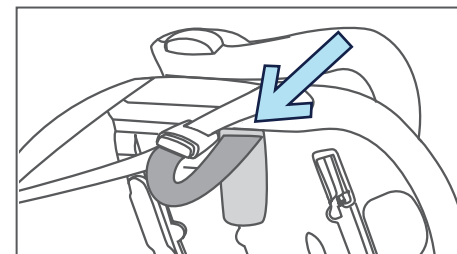
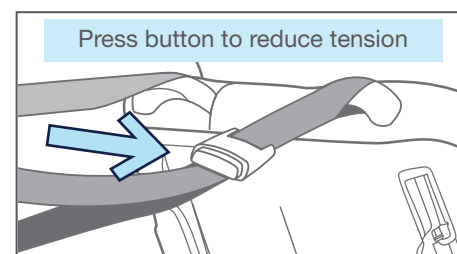

Tether Anchorage Installation

Most cars have several threaded holes to fit the tether anchorage to. Refer to the vehicle owners handbook for information on the location of these points.

Using the bolt provided attach the anchor fitting to the mounting point behind where the child restraint is to be installed.

See more detailed information on the next page.

The anchor fitting must be aligned as shown unless stated otherwise in the vehicle owners handbook.

If drilling a new hole, select a position on the centre line of the seating position, and no closer than 100 mm from the front edge of the parcel shelf.

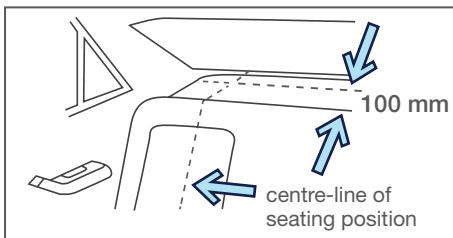
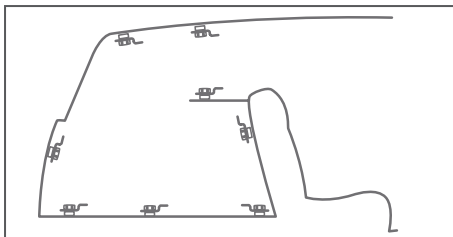
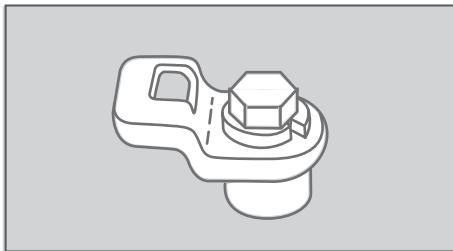
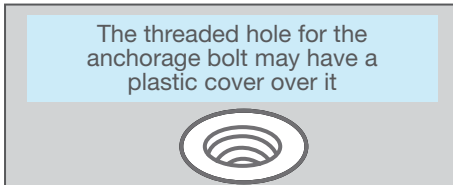

Tether Anchorage Installation

If the car is fitted with a child restraint anchorage point:

Locate the upper anchorage point behind the rear seating position (consult the vehicle owners handbook for location of the upper anchorage point). Remove the thread plug from the parcel shelf/floor/roof and install the attachment bolt as shown opposite.

CAUTION:
DO NOT OVERTIGHTEN THE ATTACHMENT BOLT. MAXIMUM TORQUE 20Nm.

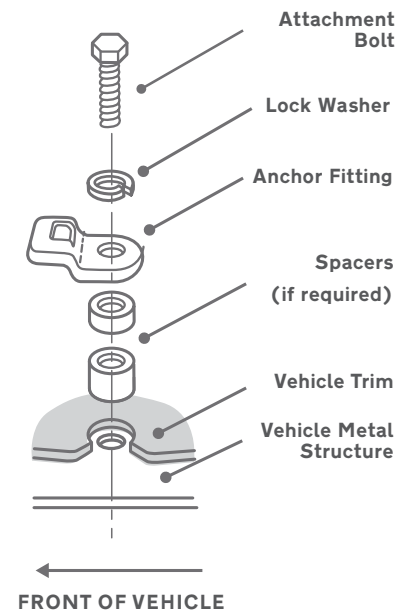

Tether Anchorage Installation

If the car is not fitted with a child restraint upper anchorage point:

For sedans only - drill a 9 mm hole in the parcel shelf on the centre line of the seating position as shown on page 40. Install the anchor bolt as shown opposite.

It is recommended that this installation be carried out by a child restraint fitting station or licenced motor mechanic.

For vehicles other than sedans:

In Australia, consult your nearest child restraint fitting station or traffic authority for vehicle inspection to find the best, correct position for the placement of the upper anchorage point, and for the correct attachment bolt length and use of spacers.

In New Zealand, consult the agent for the vehicle.

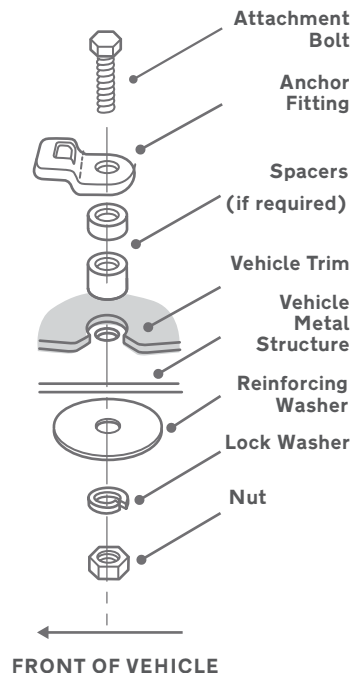

WARNING

CHILD RESTRAINTS MUST NOT BE ATTACHED TO UNSOUND METAL OR WOOD OR SYNTHETIC STRUCTURES. WHEN DRILLING THE 9 MM HOLE DO NOT DRILL THROUGH FUEL LINES, FUEL TANKS, ELECTRICAL WIRING, OR RADIO SPEAKERS. WEBBING STRAPS MUST BE PROTECTED FROM SHARP CORNERS AND EDGES.

THE ANCHOR FITTING MUST BE USED ONLY AS DESCRIBED ABOVE. IT MUST NOT BE HOOKED ONTO ANY OTHER OBJECT.