

INSTRUCTIONS FOR INSTALLATION

nuna®

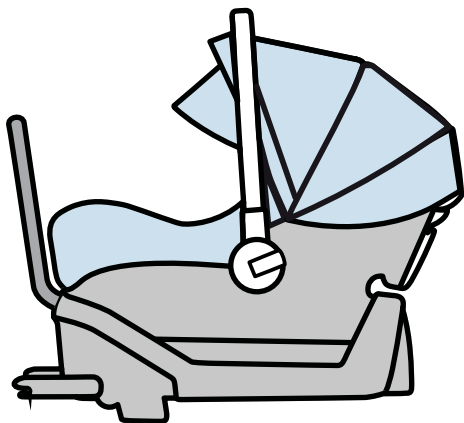

KLIK plus

SEAT AND BASE MODEL CF05702

BASE ONLY IF05702

IMG-0092B

**IMPORTANT: KEEP THIS INSTRUCTION BOOKLET IN THE
PLACE PROVIDED ON THE CHILD RESTRAINT**

IMPORTANT:

Before installation and use of this child restraint check that it is suitable for the size of your child.

See page 7 of the USE Instructions for more information.

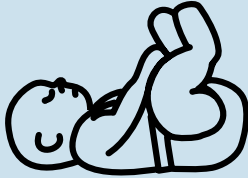

IMPORTANT: This is a rear facing child restraint. Do not face forward.

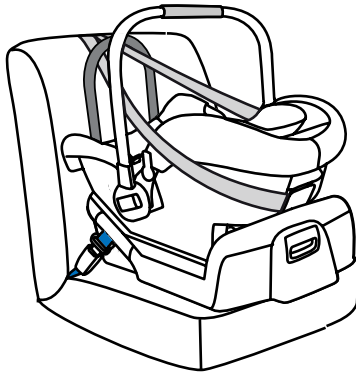

Distributed by Baby Bunting Pty. Ltd.

For after sales service, please contact:

APB Pty Ltd , 82 Bellingara Road, Miranda NSW 2228

Ph: 02 8543 5570



Contents

- Quick Reference 2
- WARNINGS** 3
- Additional Warnings** 4 & 5
- Features 6
- Installation - General 7 & 8
- Installation - Vehicle Belts 9 - 11
- Installation - ISOFIX Compatible Connectors 12 - 16
- Storage- ISOFIX Compatible Connectors 17
- Fitting Restraint to Base 18
- WARNINGS – Tether Strap** 19
- How to use the Tether Strap 20 - 22
- Installation – Tether Anchorage 23 - 25
- Use with Strollers 26
- Cleaning and Maintenance 27

DO NOT USE THIS CHILD RESTRAINT UNTIL YOU HAVE READ AND UNDERSTOOD THE INSTRUCTIONS IN THIS USER GUIDE AND IN YOUR VEHICLE OWNERS MANUAL

Quick Reference

IMPORTANT: After reading this Quick Reference read the following instructions carefully.

Tether Strap

must always be used when the restraint is installed in a vehicle. Store end of tether in bag. See page 20 - 22

Carry Handle

must always be locked into position.

Secure Latching

restraint must be securely latched into base. See page 18

Vehicle Belt (if used)

must always be secure and pulled tight. See pages 9 -11

Base Recline Adjustment

base must be reclined correctly. See pages 7 & 8

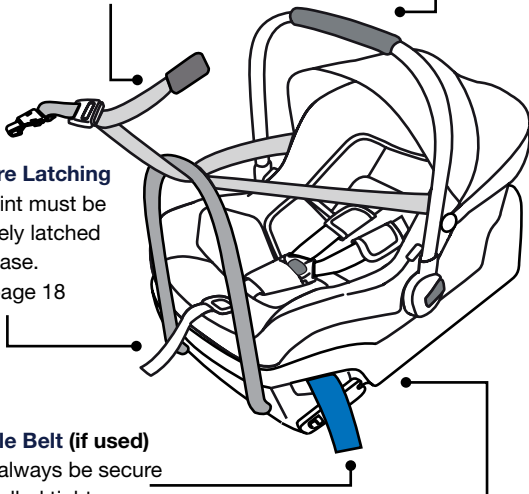

⚠ WARNING

- Use the restraint exactly as shown in the instructions.
- Fit the restraint firmly to the car seat.
- A loose harness or restraint is dangerous.
- Destroy the restraint if it has been in a severe crash, even if no damage is visible.
- Do not alter or modify this restraint.
- Repairs must only be done by the manufacturer or agent.
- **DO NOT USE A REAR FACING CHILD RESTRAINT WHERE AN AIRBAG IS FITTED IN FRONT OF THE SEATING POSITION.**
- Only use this restraint with the base it was supplied with. If a second or replacement base is required it must be a matching model number.

NOTE: The warnings on these pages are those required by the Australian and New Zealand Standard AS/NZS 1754 for this type of child restraint. Other warnings specific to this particular child restraint will be found throughout these instructions.

Read the whole of these instructions carefully and if there is any doubt about the method of installation, consult the child restraint manufacturer or agent, or a child restraint fitting station authorized by the relevant transport authority, or in New Zealand an agent for the vehicle.

⚠️ ADDITIONAL WARNINGS

TO BE USED WITH A LAP-SASH/LAP ONLY SEATBELT OR ISOFIX LOW ANCHORAGES IN THE BACK OF MOST CARS WITH FORWARD FACING SEATS.

This restraint is 700 mm long, 440 mm wide and 500 mm high (with the handle down). Check the measurement between the front of the seat back of the rear seat and all front seats in the car in which the restraint is intended to be used to ensure the space available is sufficient.

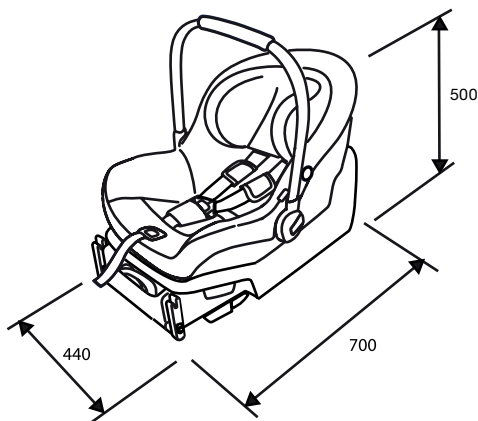

Seat belt extenders are not recommended if the car seat belt is too short to secure the child restraint. If the car seat belt is too short get advice from a child restraint fitter regarding use of these.

⚠️ ADDITIONAL WARNINGS

Only install child restraint in a forward facing vehicle seat. Never install in a seat that faces the rear or the side of the vehicle.

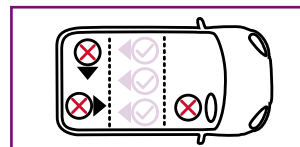

This is a rearward facing child restraint. Do not install facing the side or forwards.

Never install the Child Restraint in a seat with a front airbag. DEATH or SERIOUS INJURY may occur. Refer to your vehicle Owners Manual for airbag warnings and information.



Always check child restraint to base connection.

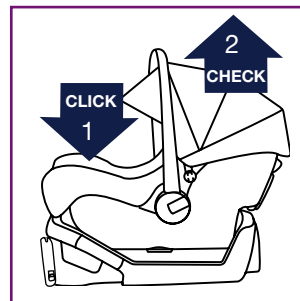

Features

- 1 Tether Strap
- 2 Child Restraint Release Lever
- 3 Tether Strap Anchorage
- 4 Tether end storage
- 5 Vehicle Belt Lock-Off
- 6 Bubble Level Indicator
- 7 Instruction Manual Storage
- 8 Recline Foot
- 9 ISOFIX connector
- 10 Recline Foot Fold Latch
- 11 ISOFIX connectors fold latch

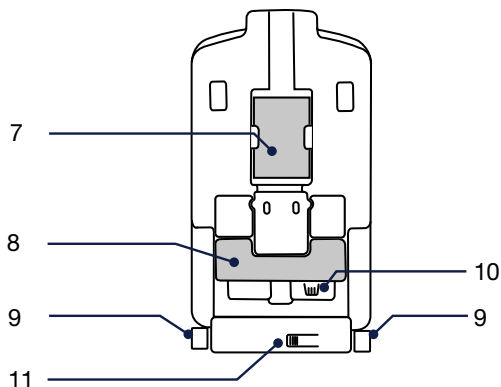
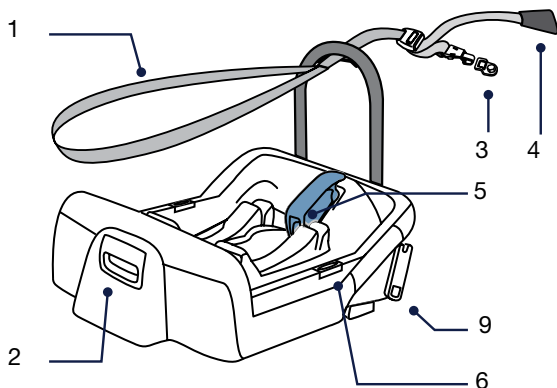

Installation - General

Where to install the child restraint?

Only install the child restraint in a forward facing vehicle seat.

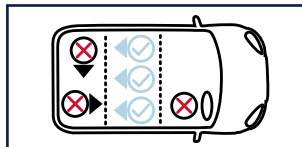

Never install in a seat that faces the rear or the side of the vehicle.

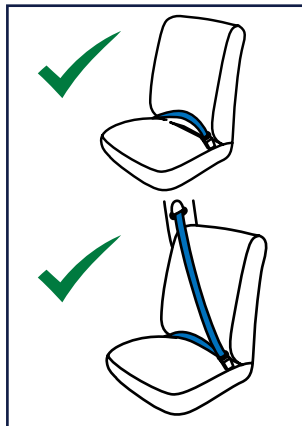

Install in the rear seat, the safest place is normally the centre.

The base can be installed on vehicles seats fitted with either a lap belt or a lap/sash belt or ISOFIX anchorages.

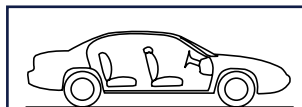

To install correctly the vehicle must be on a level surface.

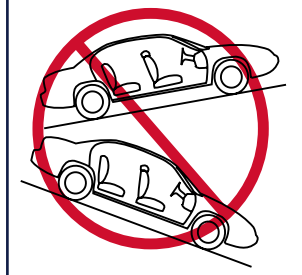

IMPORTANT:
Correct position and installation is essential for your child's safety.

1 Position base on a forward facing vehicle seat.

Adjust base so bubble is between the black patches.

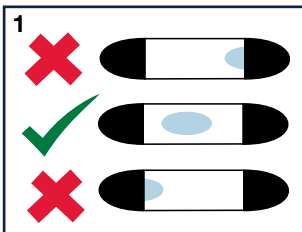

2 Use recline adjustment, if needed, to achieve correct angle for installation.

Recline adjustment foot snaps into position.

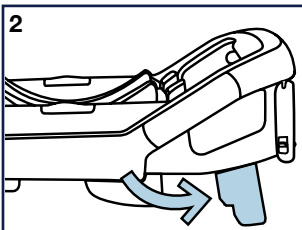

3 If the recline adjustment foot does not give sufficient recline, add a folded towel or similar.

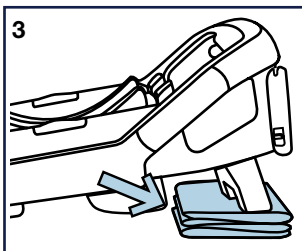

IMPORTANT:

Any extra padding placed under the base must be firmly folded so that when the vehicle belts are pulled up tight, the base is secure.

Always secure the base with a vehicle belt, even when the restraint is not fitted to it. An unsecured base may be dangerous in an accident or sudden stop.

Installation – Vehicle Belts

Use the Belt Path labels as a guide for correct belt placement.



REARWARD-FACING BELT PATH

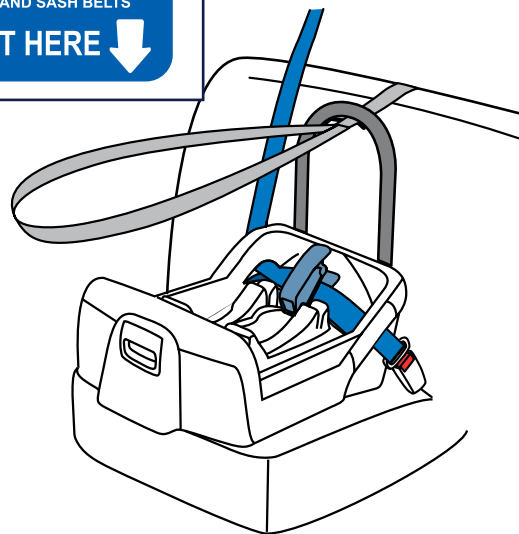

INSTALLED BASE

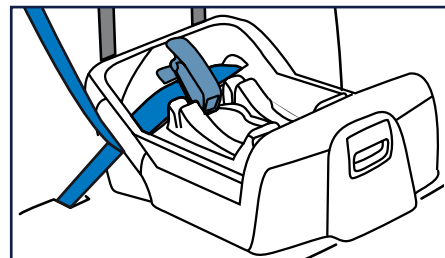

Installation — Vehicle Belts

1. Place the base on the vehicle seat and pass the vehicle belt through the openings in the base labeled 'BELT PATH'

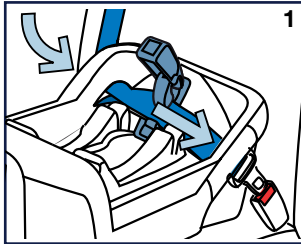

2. Open the belt lockoff and place the shoulder and lap belts across it.

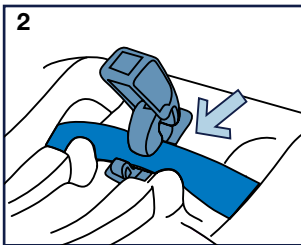

3. Buckle the vehicle belt.

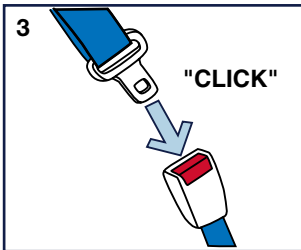

4. Push the base into the vehicle seat firmly **A** and pull the vehicle belts tight **B**.

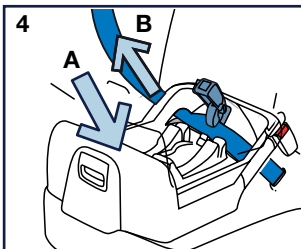

5. Hold vehicle belts tight and engage the belt lockoff.

**BELTS MUST BE TIGHT.
LOOSE BELTS ARE DANGEROUS.**

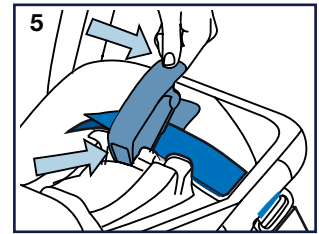

Checklist — Vehicle Belt Installation

1. Vehicle Buckle engaged.

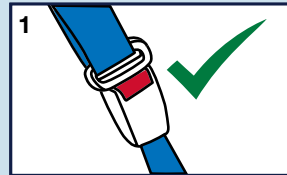

2. Vehicle belt is tight.

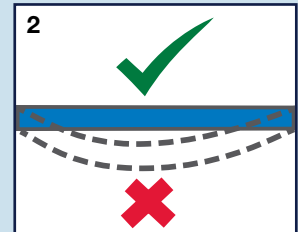

3. Vehicle belt is not twisted.

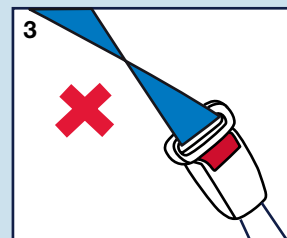

4. Level indicator bubble is fully in the clear area.

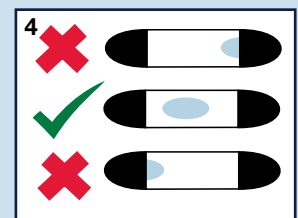

Installation – ISOFIX Compatible Connectors

Some vehicles are fitted with ISOFIX low anchorage points.

These are found at the bottom of the back seat backrest.

This child restraint has connectors to attach to them.

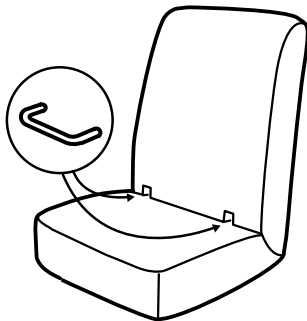

If the ISOFIX low anchorage points are not clearly visible the vehicle seat will be marked with labels to show their location.

If in doubt that the vehicle is fitted with such points check the Vehicle Owners Manual.



Some vehicles sourced from the USA may be marked LATCH.

LATCH

ISOFIX and LATCH low anchorage points are the same.

! WARNING

IMPORTANT Do not attach the lower attachment connectors of two separate child restraints to the same ISOFIX low anchorage in your car.

Always attach the top tether strap to the child restraint upper anchorage in your car.

Child restraint lower attachment connectors and the ISOFIX low anchorages in your car are designed to withstand only those loads imposed by a correctly fitted child restraint.

Installation – ISOFIX Compatible Connector Guides

- 1 Some models come with guides for the ISOFIX compatible connectors.

These are for use in cars where the anchorage bar is recessed a long way into the seats.

Once fitted they will help guide the ISOFIX compatible connector into place.

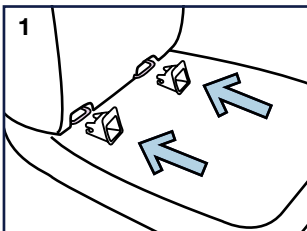

- 2 To use:

- locate the position of the ISOFIX low anchorage,
- slide the guide in until it contacts the steel rod
- allow the guide to push up until it is secure on the steel rod.

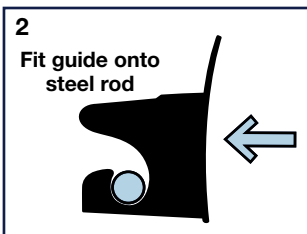

Before fitting see general installation instructions on pages 7 & 8

- 1 Press the release buttons A and swing the ISOFIX compatible connectors forward to their operating position.

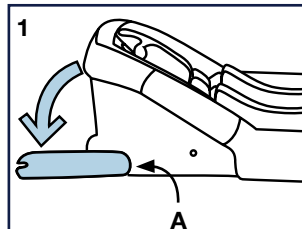

- 2 Attach each connector to the vehicle ISOFIX low anchorages.

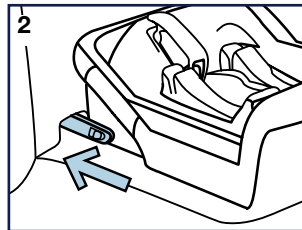

- 3 Pull the base back to ensure both lower connectors are engaged.

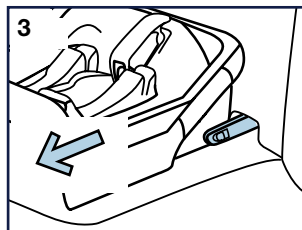
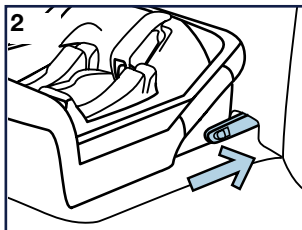

Checklist — ISOFIX Installation

1 Check the bubble level indicator to see if recline level is still correct.

Adjust if necessary.

2. Pull back to check both sides are latched securely.

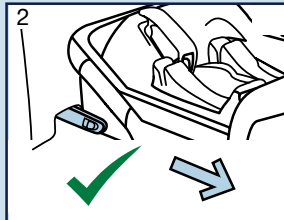
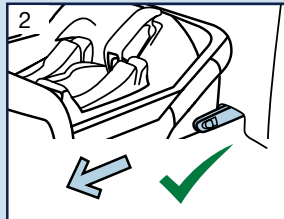
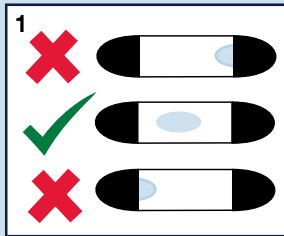

Storage — ISOFIX Compatible Connectors

Store the ISOFIX compatible connectors by pressing the release button under the base and swinging them back until they are snugly alongside the base.

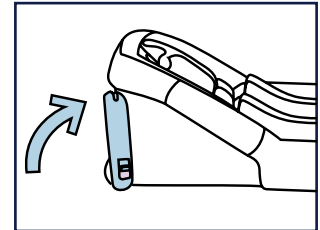
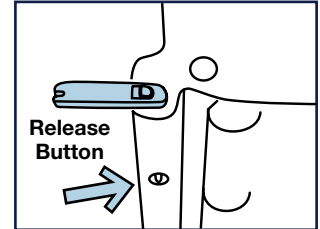

Fitting Restraint to Base

To Install

First make sure there is nothing in or on the base (blankets, toys etc).

These may stop the restraint from latching securely.

Lower the restraint down into the base. Listen for a "CLICK" from the latches in the base.

Pull up on the restraint to ensure it is securely latched.

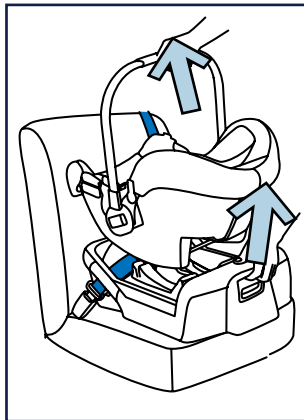
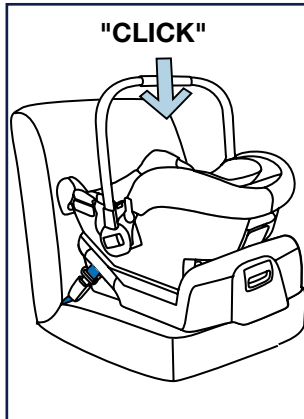

To Release

Lift the restraint with one hand while pulling up on the release latch at the back of the base.

⚠ WARNINGS – Tether Strap

THIS RESTRAINT MUST BE ATTACHED TO A CHILD RESTRAINT UPPER ANCHORAGE POINT IN THE CAR. REFER TO CAR OWNERS HANDBOOK FOR LOCATION OF ANCHORAGE POINTS.

REFER TO A CHILD RESTRAINT FITTING STATION IF NO ANCHORAGE POINTS ARE IN THE MOTOR CAR. THIS RESTRAINT IS NOT SUITABLE FOR USE WHERE THE TOP TETHER STRAP MAY FALL INTO A SPLIT IN THE SEAT BACK OR OFF THE SIDE OF THE SEAT.

Always secure the loose end of the top tether strap to prevent it hanging out of the car or being accessible by the child.

It should be stored in the bag provided on the end of the strap.

Do not use the child restraint where this strap may fall into a split in the seat back or off the side of the seat.

ALWAYS ATTACH HOOK AND REMOVE SLACK. CAUTION: CHILDREN CAN BE INJURED OR RESTRAINTS AND TOP TETHER STRAP DAMAGED BY UNSECURED CARGO IN A COLLISION. SECURE OR REMOVE HAZARDOUS CARGO BEFORE USING THIS CHILD RESTRAINT.

In some vehicles without a fixed parcel shelf an extension tether strap may be required. These are available in several different lengths and can be obtained from child restraint retail outlets.

How to use the Tether Strap

Always use the tether strap.

Connect the tether strap to the built-in anchorage fitting in the vehicle, or if there is not one available, install the anchor fitting supplied with this restraint.

Store the extra webbing in the bag attached to the end of the tether.

NOTE: the tether strap wraps around the sides of the restraint, not over the top.
If the canopy is fitted the tether passes outside it.

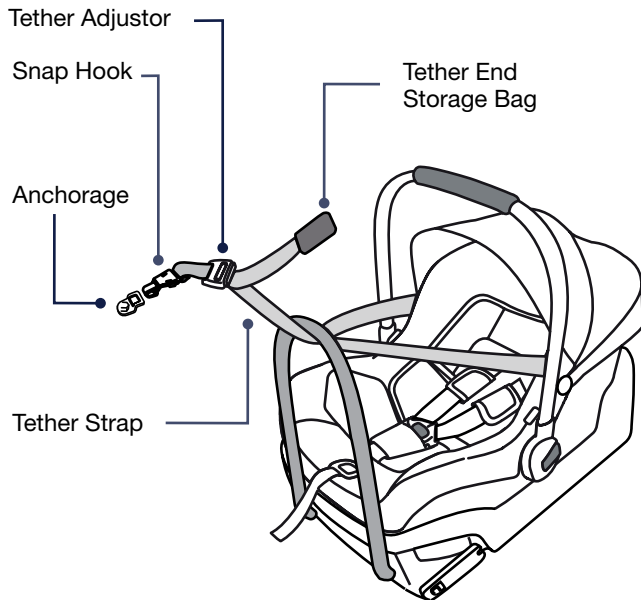

How to use the Tether Strap

When the restraint is in a vehicle always fit the tether into the guide at the back.

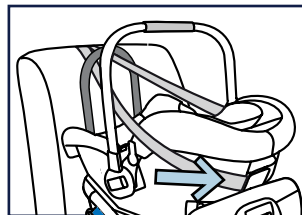

Always connect the snap hook securely to the anchorage fitting.

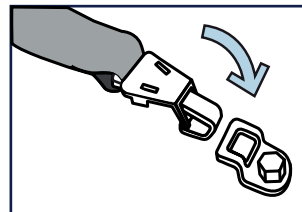

To increase webbing tension pull upper strap through adjustor.

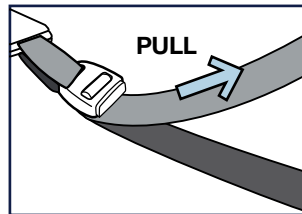

To release webbing tension press adjustor button and pull lower strap.

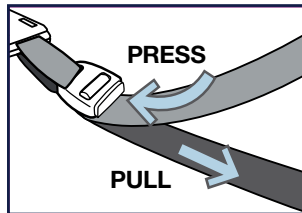

How to use the Tether Strap

Do not adjust so tight that it lifts the child restraint off the vehicle seat.



Store unused web in bag on end of tether.

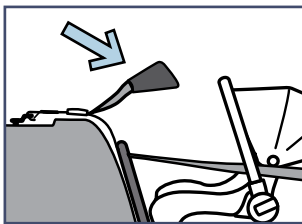

Straps must not be twisted

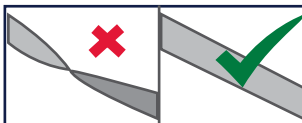

Installation — Tether Anchorage

Most cars have several threaded holes to fit the tether anchorage to. Refer to the vehicle owners handbook for information on the location of these points.

Using the bolt provided attach the anchor fitting to the mounting point behind where the child restraint is to be installed.

See more detailed information on the next page.

The anchor fitting must be aligned as shown unless stated otherwise in the vehicle owners handbook.

If drilling a new hole, select a position on the centre line of the seating position, and no closer than 100 mm from the front edge of the parcel shelf.

The threaded hole for the anchorage bolt may have a plastic cover over it

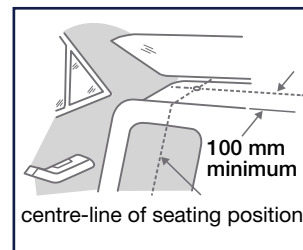
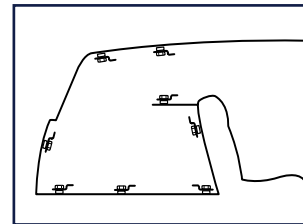
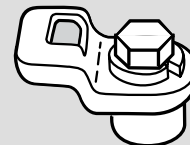

Installation — Tether Anchorage

If the car is fitted with a child restraint anchorage point:

Locate the anchorage point behind the rear seating position (consult the vehicle owners handbook for location of the anchorage point). Remove the thread plug from the parcel shelf/floor/roof and install the attachment bolt as shown opposite.

CAUTION:
DO NOT OVERTIGHTEN THE ATTACHMENT BOLT.
MAXIMUM TORQUE 20Nm.

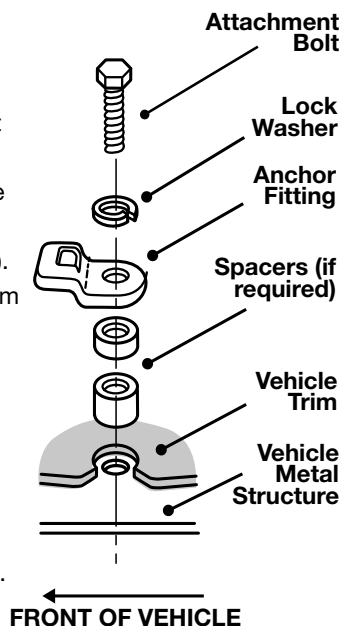

WARNING

CHILD RESTRAINTS MUST NOT BE ATTACHED TO UNSOUND METAL OR WOOD OR SYNTHETIC STRUCTURES. WHEN DRILLING THE 9 MM HOLE DO NOT DRILL THROUGH FUEL LINES, FUEL TANKS, ELECTRICAL WIRING, OR RADIO SPEAKERS. WEBBING STRAPS MUST BE PROTECTED FROM SHARP CORNERS AND EDGES.

THE ANCHOR FITTING MUST BE USED ONLY AS DESCRIBED ABOVE. IT MUST NOT BE HOOKED ONTO ANY OTHER OBJECT.

Installation — Tether Anchorage

If the car is not fitted with a child restraint anchorage point:

For sedans only - drill a 9 mm hole in the parcel shelf on the centre line of the seating position as shown on page 23.

Install the anchor bolt as shown opposite.

It is recommended that this installation be carried out by a child restraint fitting station or licenced motor mechanic.

For vehicles other than sedans - In Australia, consult your nearest child restraint fitting station or traffic authority for vehicle inspection to find the best, correct position for the placement of the anchorage point, and for the correct attachment bolt length and use of spacers. In New Zealand, consult the agent for the vehicle.

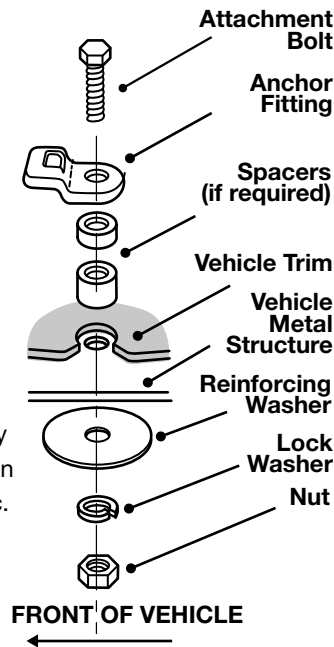

Use with Strollers

This NUNA™ child restraint can attach to Nuna strollers using adapters. Instructions are included with the adapters, which are sold separately.

Please visit www.nuna.com for more information.

Cleaning and Maintenance

Seat Cover

Wash with cold water and mild detergent.

Do not iron.

Do not bleach or dry clean.

Do not twist the soft goods to dry with great force. It may leave the seat cover with wrinkles.

Hang dry the seat cover in the shade.

Plastic and Metal Parts

Use only mild detergent, water and a soft cloth to clean the car seat shell, handle and harness straps. Air dry.

Do not use undiluted detergent, or other solvents to clean - these may cause damage.

Harness Buckle

To clean the buckle: rinse using warm water. DO NOT use any soaps, solvents or lubricants. Using anything other than water can cause the buckle to malfunction. Air dry.

When the buckle is operating correctly the tongues will push in easily and will CLICK when they latch into place.

If the buckle does not appear to be working correctly get it checked or replaced by contacting the retailer from where it was purchased.

Harness Straps

Spot clean. If damaged contact the retailer from where the restraint was purchased to have them replaced.

Storage

Remove the child restraint from the vehicle seat if not in use for a long period of time. Put the child restraint in a cool, dry place and somewhere your child cannot access it.